



The EXPERT Vegetable Processor is perfect for high-volume use in larger restaurants, supermarkets and delicatessens.



Heavy Duty; Belt-driven; Manual Operation

Model
EXPERT
Vegetable Processor

Model EXPERT Vegetable Processor

CE Approved

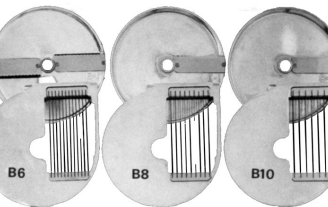
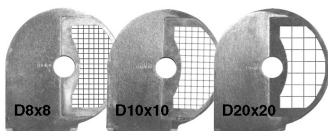
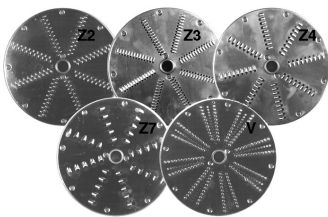
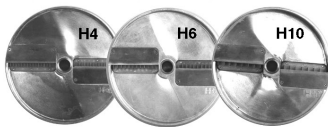
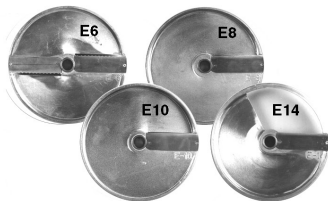
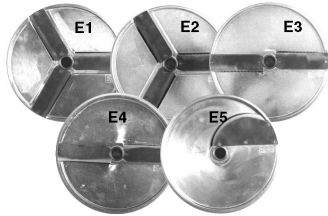

The EXPERT Vegetable Processor has been designed for high-volume use in larger restaurants, supermarkets and delicatessens.

Convenience features include, fast blade change and dual inlet chutes, which make for fast and efficient slicing of any kind of fruit or vegetable in the busiest environment.

- Manufactured in anodised aluminium and stainless steel to resist the corrosive effects of salts and acids;
- Constructed for easy cleaning;
- Up to 60 different slicing and grating combinations;
- Safety interlock switches prevent operation if the machine is opened or the feeder handle is not closed;
- Forced ventilation to motor.

SPECIFICATIONS

Model	EXPERT
Blade (mm)	205
Motor	240V, 50Hz, 800W
Net weight (kg)	27
IP Rating	65
Dimensions (mm)	
Width	275
Depth	490
Height	490

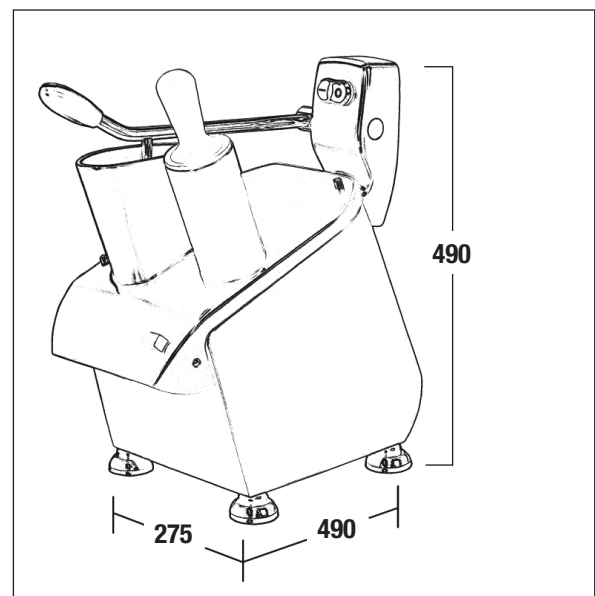

SLICING DISCS

E1, E2, E3, E4, E6, E8, E10 & E14: For slices from 1 to 14 mm. Potato chips, potato, turnip, cabbage, cucumber, carrot, mushroom, onion, marrow, aubergine, fennel, artichoke.

E5, E15 & E25: For slices from 1 to 5 mm. Hard salami, mushroom, tomato, lemon, orange, apple, banana, pineapple, grapefruit, etc.

E30, E40, E60, E80, E100, & E140: For fruit and vegetable waved slices from 1 to 14 mm.

MATCH-LIKE CUTTING DISCS

H2.5, H4, H6, H8 & H10: Celery, marrow, beetroot, carrot, potato, cabbage, etc.

SHREDDING OR GRATING DISCS

Z2, Z3, Z4 & Z7: Carrot, celery, potato, apple, turnip, beetroot, red cabbage, cheese, chocolate, etc.

V: Cheese, dry bread, nuts, chocolate, etc.

CUBIC CUTTING DISCS

D8x8, D10x10, D12x12, D16x16 & D20x20: Used in combination with any of the E series discs produces three different sizes of cubes or strips for use in soups, fruit salads, etc.

CHIPPING GRID DISCS

B6, B8 & B10: Use in combination with E series discs to obtain matchlike chips. Use with the E0 series discs to produce chips with waved sides.



Brice Australia Pty. Ltd. ABN 71 413 589 669
100% Australian owned and operated
Copyright ©2017 Brice Australia Pty. Ltd.

BRICE HEAD OFFICE:
11 Holloway Drive,
Bayswater, Victoria 3153 Australia

Ph: 1300 664 880
www.briceaust.com.au
email: info@briceaust.com.au